

Data Sheet

ECAM44660B US/CA

Date : 15.12.2016

TECHNICAL DATA

Voltage	V/Hz	120 / 60
Max.input power	W	1250

COFFEE SECTION

Temperature probe	°F	208
Thermal fuse TCO	°F	378
Heating element	W	1200
Pump	TYPE	ULKA EAP5 – W 52

STEAM SECTION

Temperature probe	°F	293
Thermal fuse TCO	°F	604
Heating element	W	1000

Wiring diagram

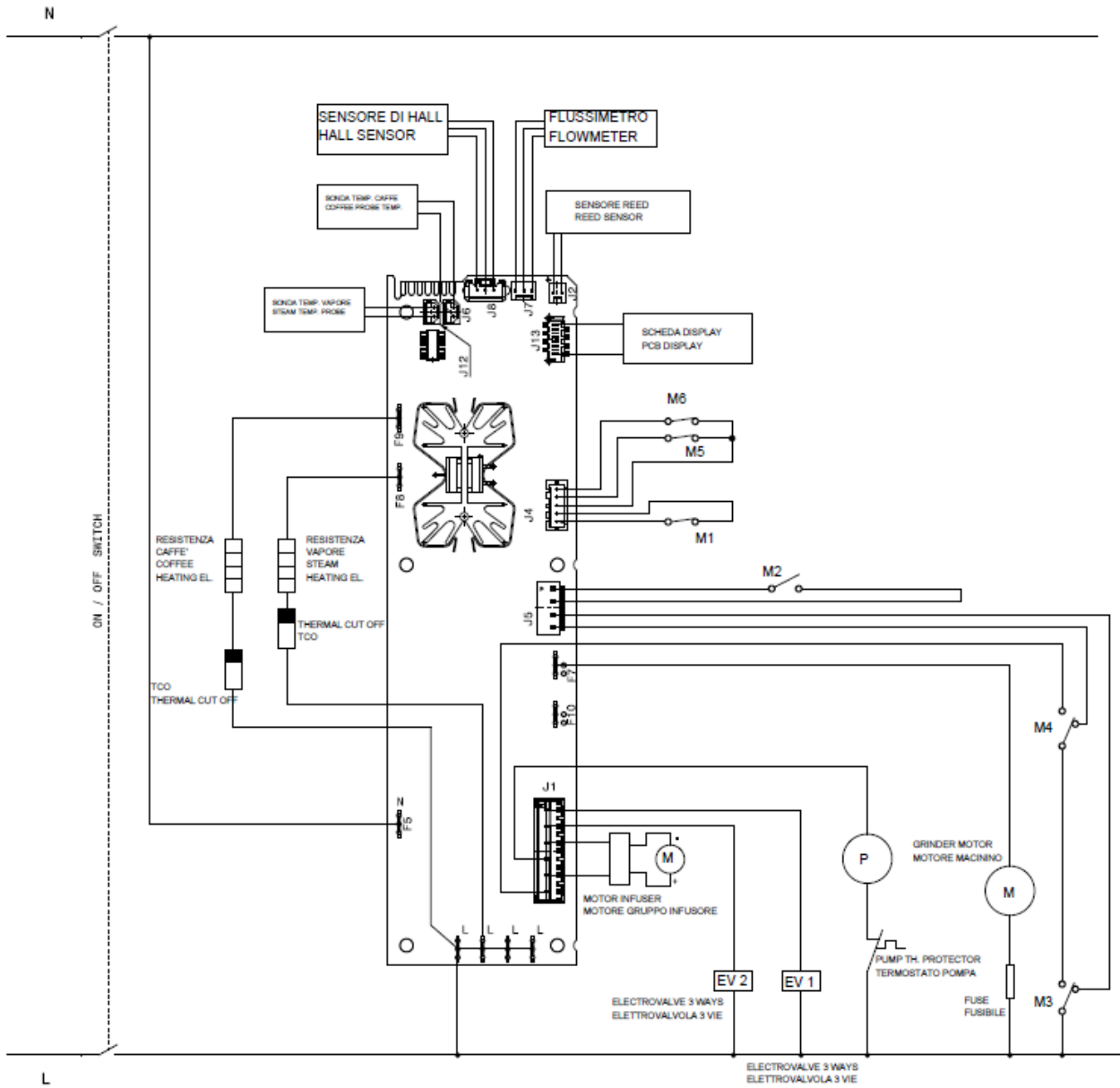

LEGENDA MICRO / MICROSWITCHES	
M1	Infusore alto / top infuser
M2	Infusore basso / Infuser bottom position
M3	Cassetto fondi / Coffee grounds container
M4	Seratoio acqua / Water Tank
M5	Presenza dispositivo IFD / IFD device in place
M6	Presenza erogatore acqua calda / Hot water spout in place

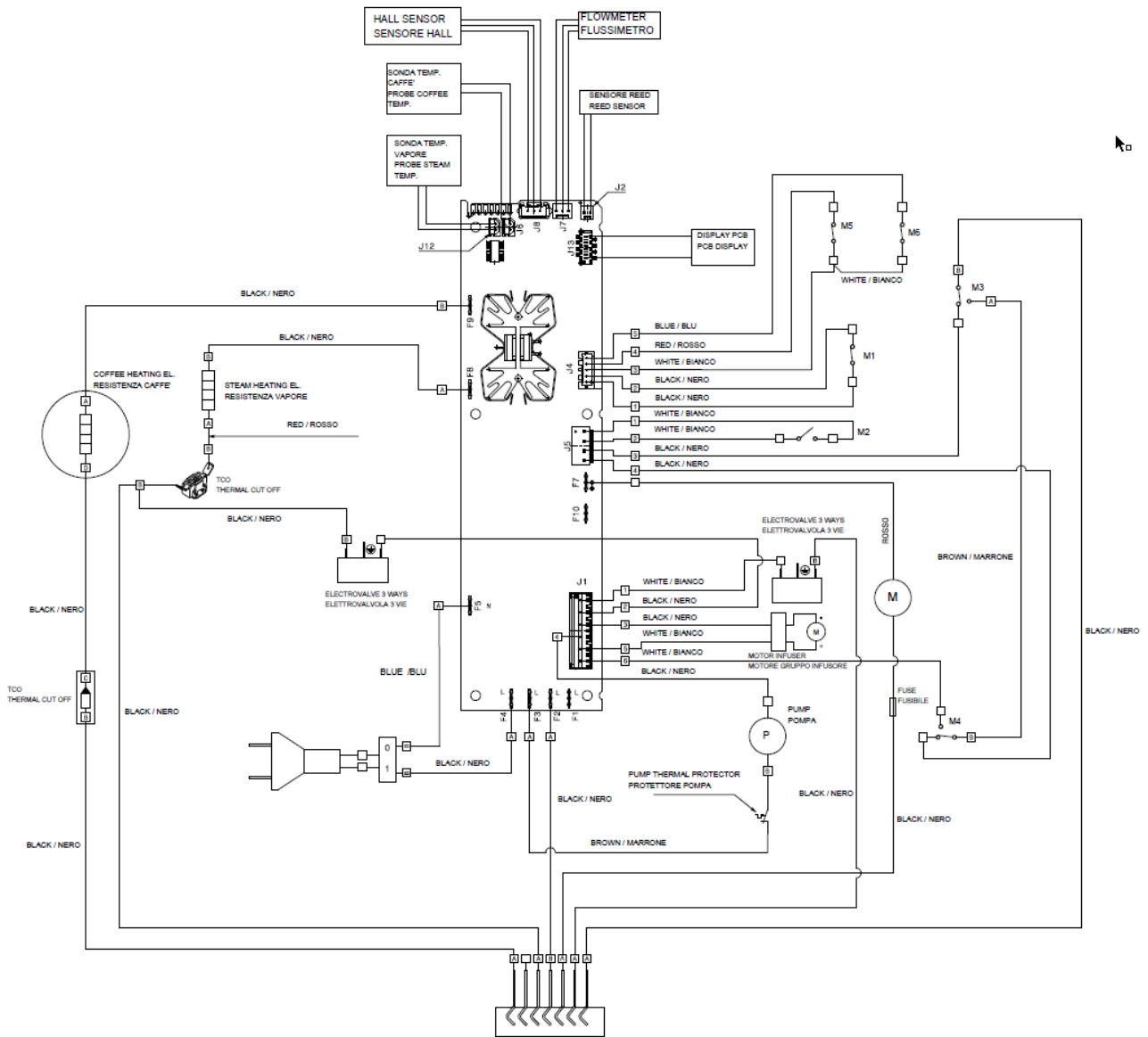

Hot water circuit

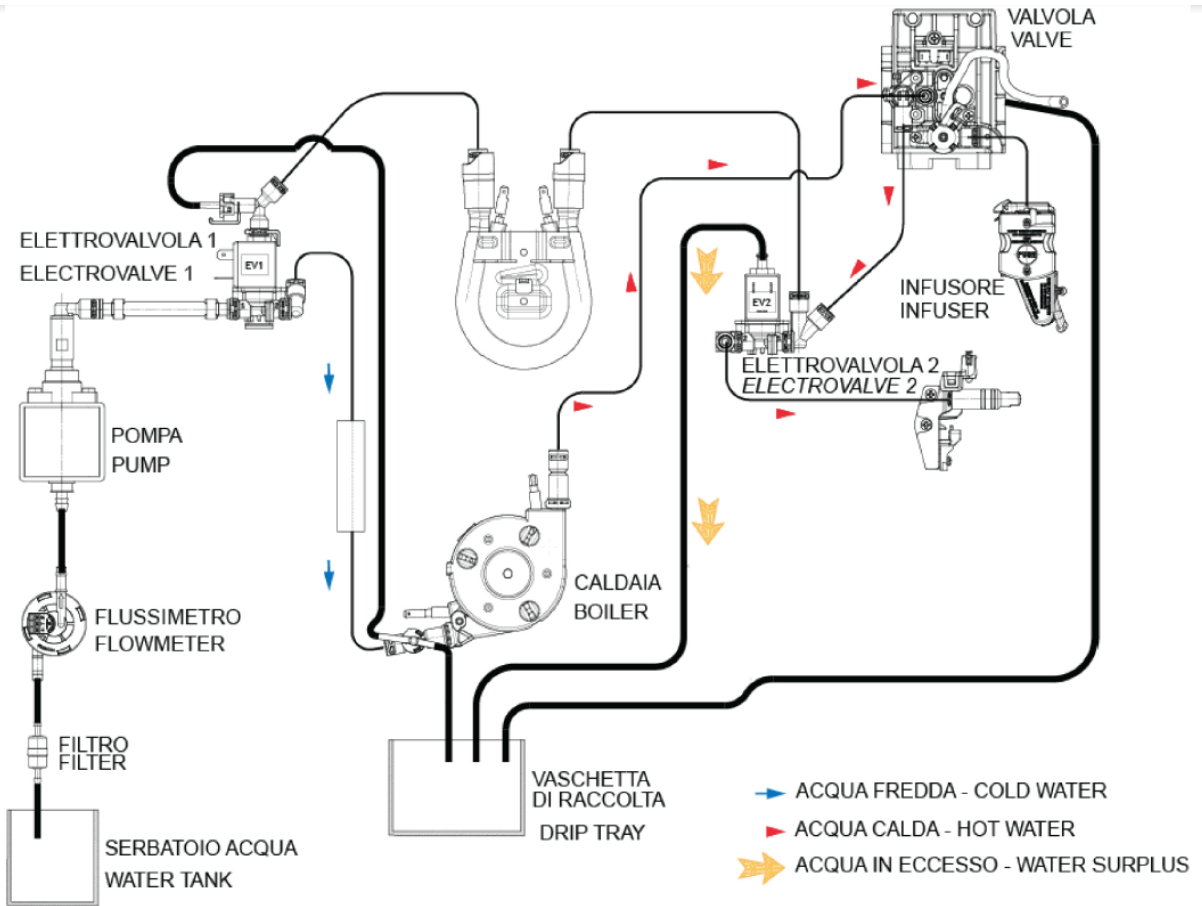



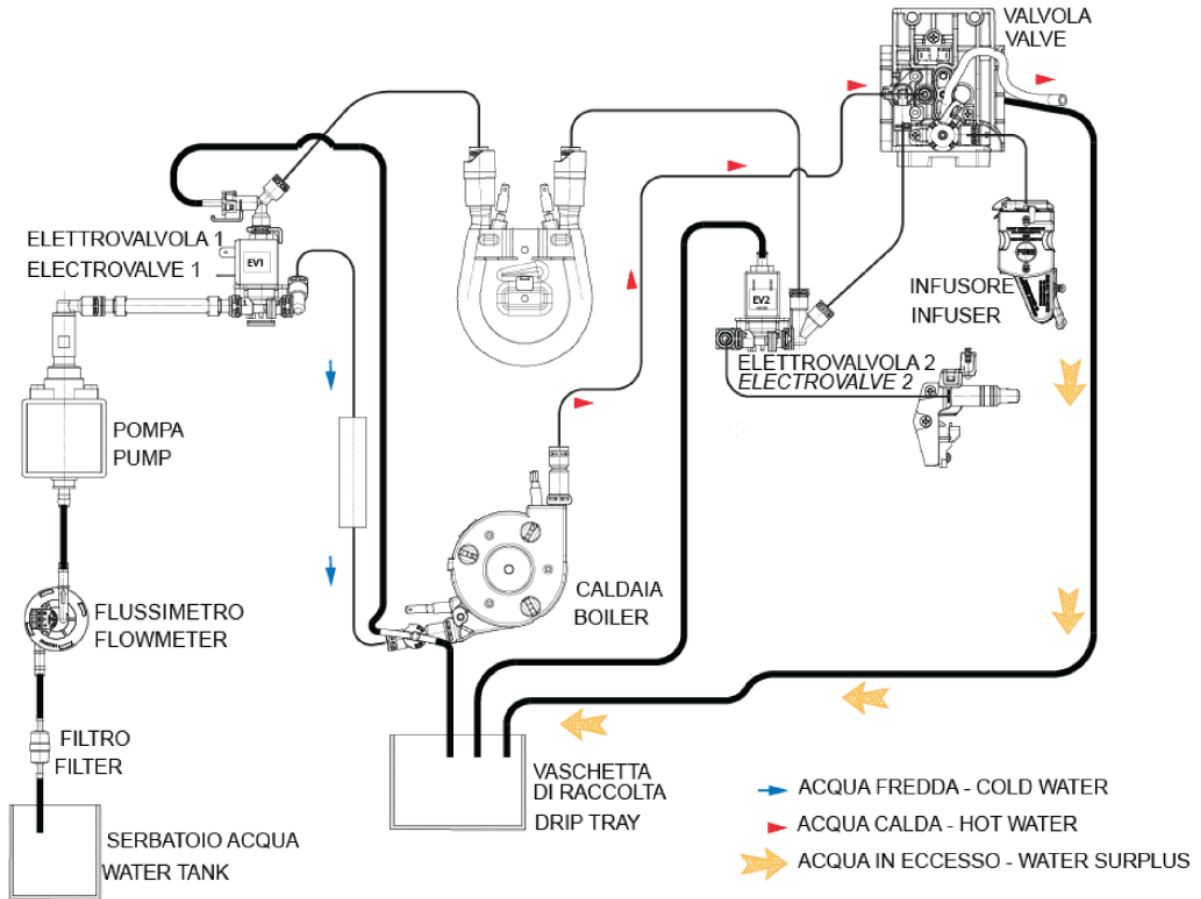



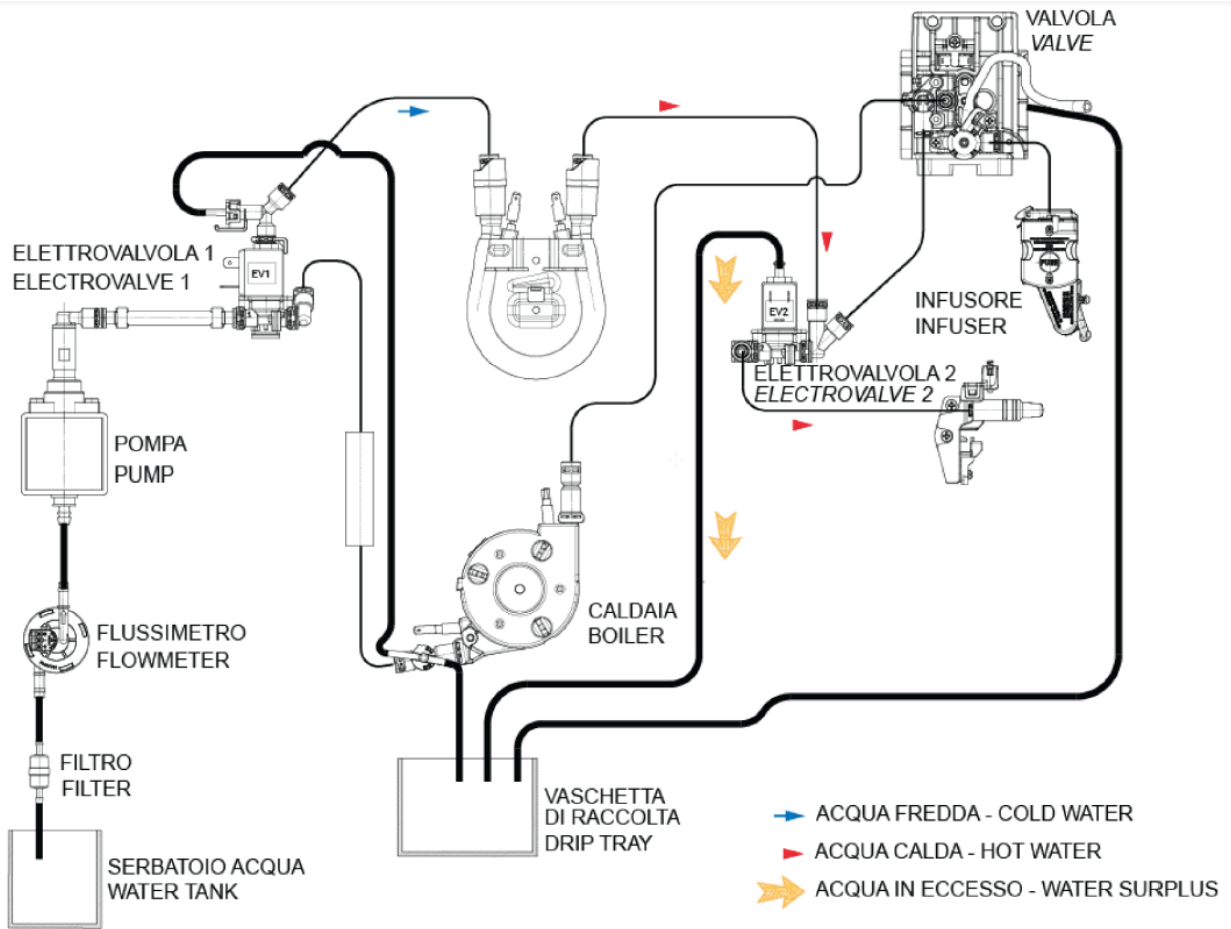











Coffee circuit



Steam circuit



Test mode

TEST	PROCEDURE	CORRESPONDENCE		NOTE	
		BUTTON	LOAD		
LOAD TEST MODE	With the appliance in stand-by (appliance off and main switch set to "I"), open the Coffee grounds container and press the following icons: Wait for a few seconds, until the message "SELECT TEST MODE" is displayed; Release the icons close the Coffee grounds container; Press 2 TAZZE (within 5 seconds): the message "LOAD TEST MODE" is displayed.		HEATER ON	Set point 96C	
		OK	STEAMER ON	Set point 140C	
			PUMP ON		
			GRINDER ON		
			MOTOR UP/ DOWN	The microswitch emit the tone when activated (reservoir and grounds drawer included)	
			EV1 ON		
			EV2 ON	Only with accessories included	
			EV1+EV2 ON	Only with accessories included EV1	
DISPLAY TEST MODE	With the appliance in stand-by (appliance off and main switch set to "I"), open the Coffee grounds container and press the following icons: Wait for a few seconds, until the message "SELECT TEST MODE" is displayed; Release the icons close the Coffee grounds container; Press 1 TAZZE (within 5 seconds): the message "BUTTON" is displayed.		BUTTON 1	Access to the display test mode reset the language setting enables the first trigger	
		MENU ESC	BUTTON 2		
		OK	BUTTON 3		
			BUTTON 4		
			BUTTON 5		
			BUTTON 6		
			BUTTON 7		
			BUTTON 8		
			BUTTON 9		
			BUTTON 10		
			BUTTON 11		
ENCODER RESET MODE	With the appliance in stand-by (appliance off and main switch set to "I"), open the Coffee grounds container and press the following icons: Wait for a few seconds, until the message "SELECT TEST MODE" is displayed; Release the icons close the Coffee grounds container; Press "ACQUA CALDA"				To confirm that the transaction appears on display written "ENCODER RESET MODE". In order to conclude the procedure correctly, turn on the machine by delivering a rinse and then run the off